

EPT15H-65L LOW PROFILE

LITHIUM PALLET TRUCK



24 HOURS
BUILT TO WORK

65mm Lowered Fork Height



midland
pallet trucks

TRITON

COMPACT **LOW PROFILE** **STRONG**

**LOW
PROFILE**

Move low-entry pallets without the effort of a manual Pallet truck.

Our new 1500kg Triton Low Profile Fully Electric Pallet Truck has been designed for applications where a standard electric pallet truck simply will not fit.

With a lowered fork height of just 65mm, it gives operators easier access to low pallets, stillages, disposable pallets, export pallets and other specialist loads with reduced clearance.

Low profile pallet trucks have traditionally been manual, which can make heavier or repetitive handling tiring and time-consuming. This model offers a smarter alternative: a fully electric low profile pallet truck with powered travel, powered lifting and powered lowering, helping reduce operator strain while improving productivity in warehouses, workshops, supermarkets, delivery vehicles and loading areas.

Compact, strong and easy to control, this low profile electric pallet truck is ideal for businesses that need the convenience of a 65mm lowered fork height pallet truck, with the efficiency of electric powered operation. The 1500kg capacity makes it suitable for everyday material handling, while the brushless drive motor and removable lithium battery help keep maintenance low and uptime high.

Why Choose a Low Profile Electric Pallet Truck?

A standard pallet truck is not always suitable for non-standard pallets or low-clearance loads. This Triton low profile electric pallet truck is built to solve that problem. The 65mm fork height allows the truck to enter lower pallets that would usually require a manual low profile pallet truck or alternative handling equipment.



SMART POWERFUL DURABLE

BUILT TO WORK
24
HOURS

SMART SIZE

ALMOST SAME

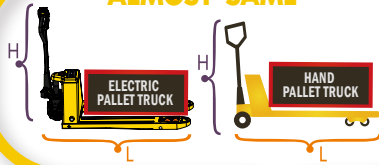

LIGHT WEIGHT



ONLY 125kgs

80kgs

EFFICIENCY

3 Times Higher Than Manual Pallet Truck



VS



LIFETIME

3 Times Longer Than Manual Pallet Truck



1 PC

VS

3 PCS

EASY MAINTENANCE

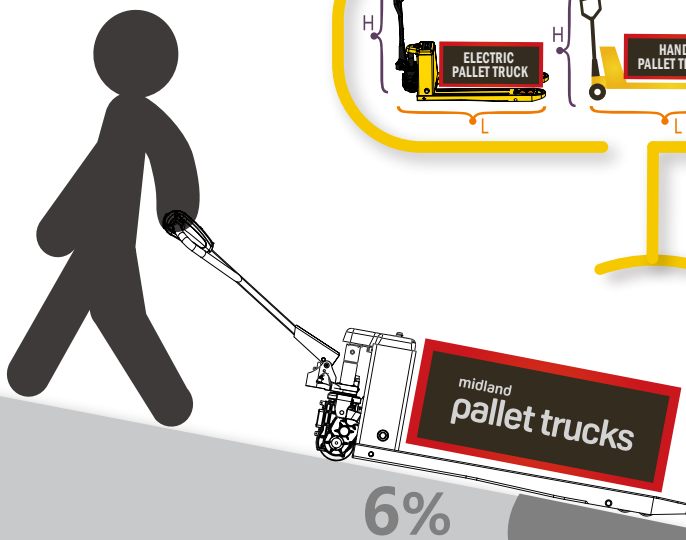
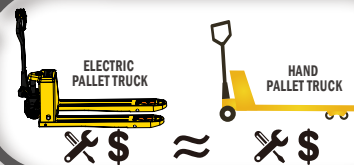

6%

HIGH RETURN OF INVESTMENT

Safety

PRODUCTIVE

1 MONTH COST RECOVERY

Optimize your operations
SAVE LABOUR
Brake any time anywhere

Release manpower

midland
pallet trucks

Powerful With High Gradeability



Unique brushless technology

Brushless motor, powerful and maintenance free.
Leading in the industry.



1000W power
Brushless motor
Maintenance free



Powered traveling



Powered lifting & lowering

Maintenance free

For brushed motor, carbon brush needs to be replaced every 12 or 18 months.
For EPT15H, no need to replace carbon brush.
Maintenance-free, saving maintenance time and cost.

Powerful with high gradeability

To easily move 1.5 ton or 2 ton over the slopes at warehouse entrances.



Traveling speed

— **UNLADEN** 4.5km/h
+ **LADEN** 4km/h

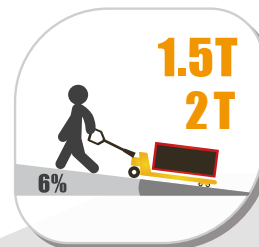
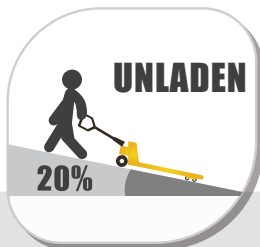

Gradeability



Non-stop Working

6s to replace battery

Maintenance-free lithium battery
It takes only 6s to replace battery.
With a spare battery, the unit can keep working 24 hours.

Ensured battery safety

Safe and reliable, no fire, no explosion.
Complying with IEC, UL global standard certification requirements, ensuring the safety of user property.

- Long service life: lithium battery with a long service life.
- High safety performance: it adopts soft package battery technology, built-in protection board and multiple protection to eliminate overcharge and overdischarge.
- Maintenance free: no need to add water.

Compact and durable

Solid build, no breaking

Chassis made by solid materials, no bending, no deformation.
Reinforced rocker arm, push rod, wheel frame and support seat.
No plastic part, less damage.

Most compact unit with same lifting capacity

Suitable for small workplaces such as compact workshops, trucks or vans, tail lifts or elevators.
EPT15H has the smallest turning radius among similar products.

Integral forks, no splicing

The forks are uniquely designed, easy to handle European pallets, American pallets and plastic pallets.
Solid fork with no deformation, far more durable than other brands of the same category.

Short charging time Charge and use freely

Quick charging: 2 hours to fully charge the battery using the optional Quick charger.

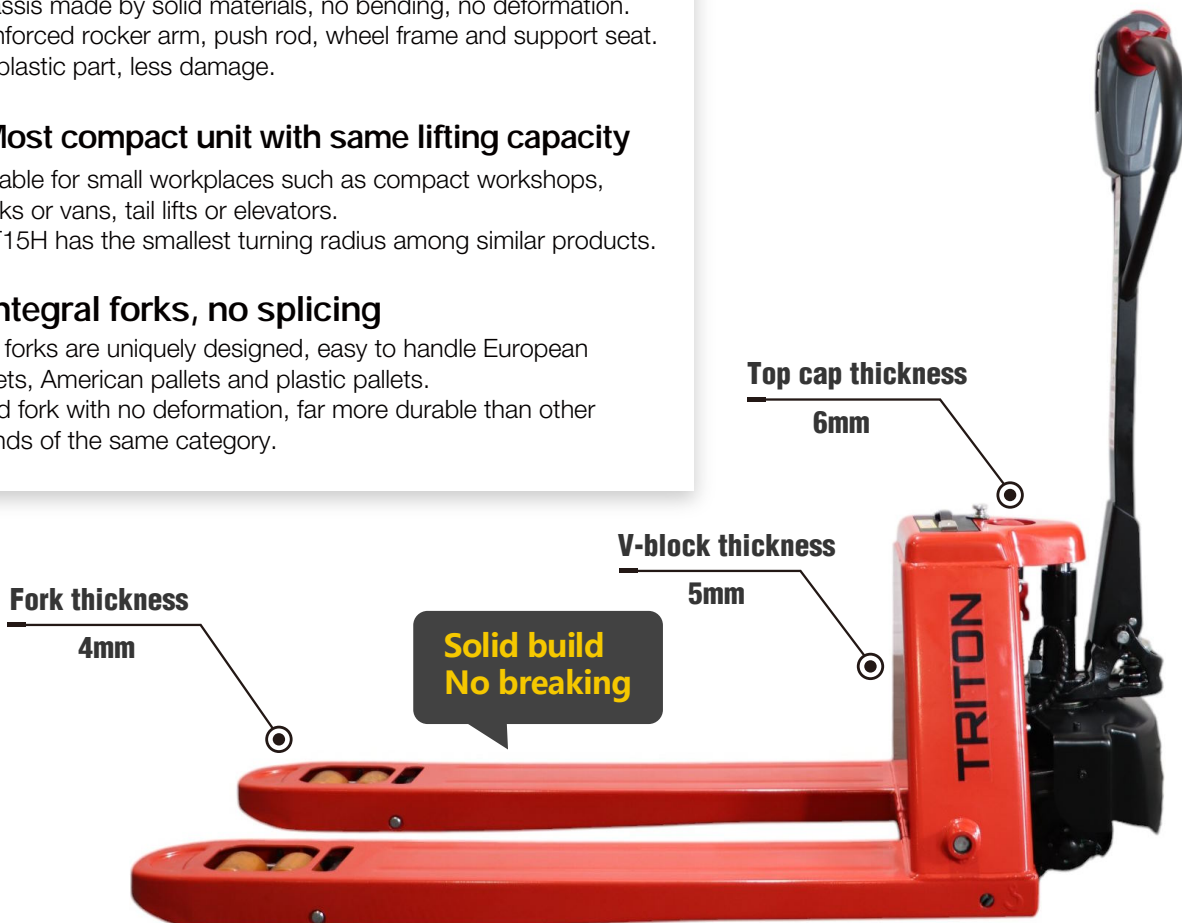

Intelligent Control

When you're moving heavy loads in tight spaces, maneuverability and controllability are critical to ensure safety, productivity and comfort.

The core concept of MIDLAND products is to make your job easier. With the ergonomically designed handle, EPT15H is easy to operate, reduces fatigue and improves work efficiency. Compared to other brands, users prefer to use MIDLAND EPT series.

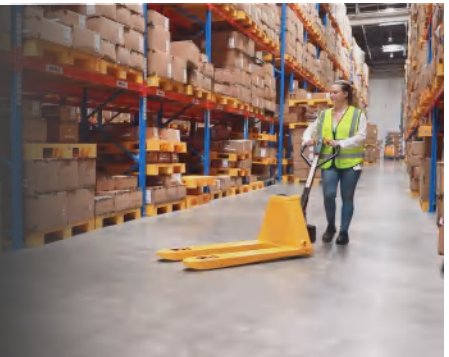

Operator Preferred

Turtle Speed

01

Horn Remains Pressed & Forward 2 times

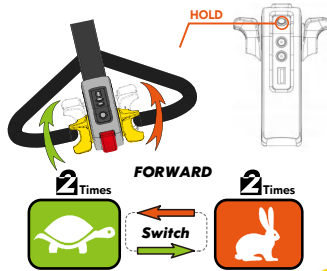

Up-Right Drive

02

Reverse Button & Forward Throttle Remain Pressed Power On

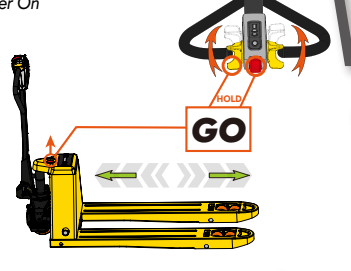

Engineering Mode (Brake Release)

03

Horn Remains Pressed Power On

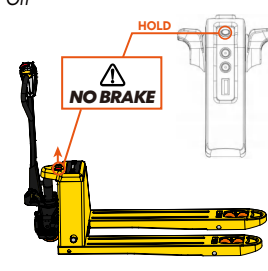

- ⚠ In up-right drive mode, vehicle will move when handle is operated at any position. Please avoid misoperation.
- ⚠ Brake release mode is only for emergencies, not allowed for vehicle with normal conditions.

Comfortable Operation

Easy to operate
Ergonomic handle, comfortable to use.

Leading Technology

CanBus technology is applied on this entry-level electric pallet truck.

Fast And Slow Speed

To match different levels of operator experience, and varied work environments.

Up-right Drive Mode

Convenient to operate in vans, on tail lifts, or inside elevators.

Engineering Mode

When the unit breaks down, it can be moved away manually.



- 🔌 Recharge alert
- 🔋 40% Hour meter
- 🌀 Powered traveling
- ⬆️⬆️ Powered lifting & lowering
- ⚠ Error code display
- 🛑 Emergency stop button
- 🔊 Horn

Slope anti-sliding design

Easy parking on slopes, preventing accidental backing of the machine.

Easy Maintenance

EPT series utilizes MIDLAND's integrated diagnostics, error code display and MIDLAND's original service mini-program to facilitate quick problem resolution.

Easy parts replacement

The unique design makes disassembly and assembly simple, reducing machine downtime and operating costs.

- **1 minute**
Replace the drive wheel
- **1 minute**
Replace the handle
- **2 minutes**
Remove the controller
- **3 minutes**
Remove the motor



Error Code Display

Quickly identify the fault during operation.

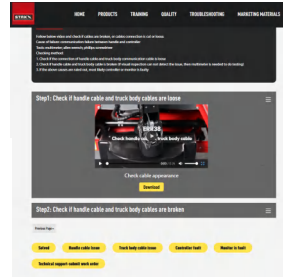

Specialized service website & mini-program

Users can identify the fault based on the online troubleshooting videos. No limit on time, no limit on location. Easy access to the most professional solution to all possible truck failures.

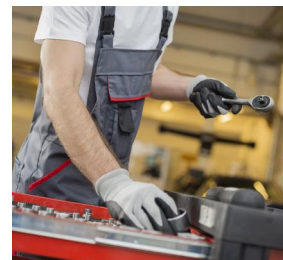

Professional after-sales support

Specialist guidance is a phone call away.

Ready to Handle Multiple Jobs

With its unique design, EPT series is powerful and maneuverable to meet the application in a wide range of working conditions.

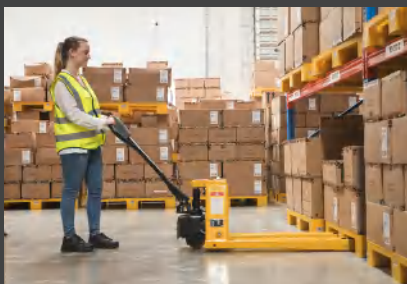

Warehouses/Logistics center



Truck tail lift



Supermarket

Pallet trucks are a necessary investment. Choosing the wrong machine could cause loss in productivity, high cost of machine downtime, unhappy workers, and overall, increased running costs. Choosing EPT series will reward you with long-term value.

MIDLAND EPT Series

- **Powerful**
- **Durable**
- **Easy maintenance**
- **Low use cost**
- **High return on investment**

Basic Configuration

- Horn
- Emergency reverse button
- Forward/reverse butterfly switch
- Lifting / Lowering
- LCD Screen
 - Battery indicator with hour meter
 - Error code display
 - Recharge alert

EPT20-A

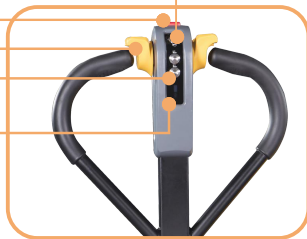

Multi-function Handle
(Full Electric)

PPT20-A



Multi-function Ergonomic Handle
(Semi-electric)

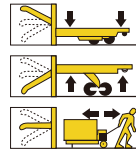

Tandem/Single PU wheel

Low profile forks

Lowered fork height: 65mm
Standard model: 82mm

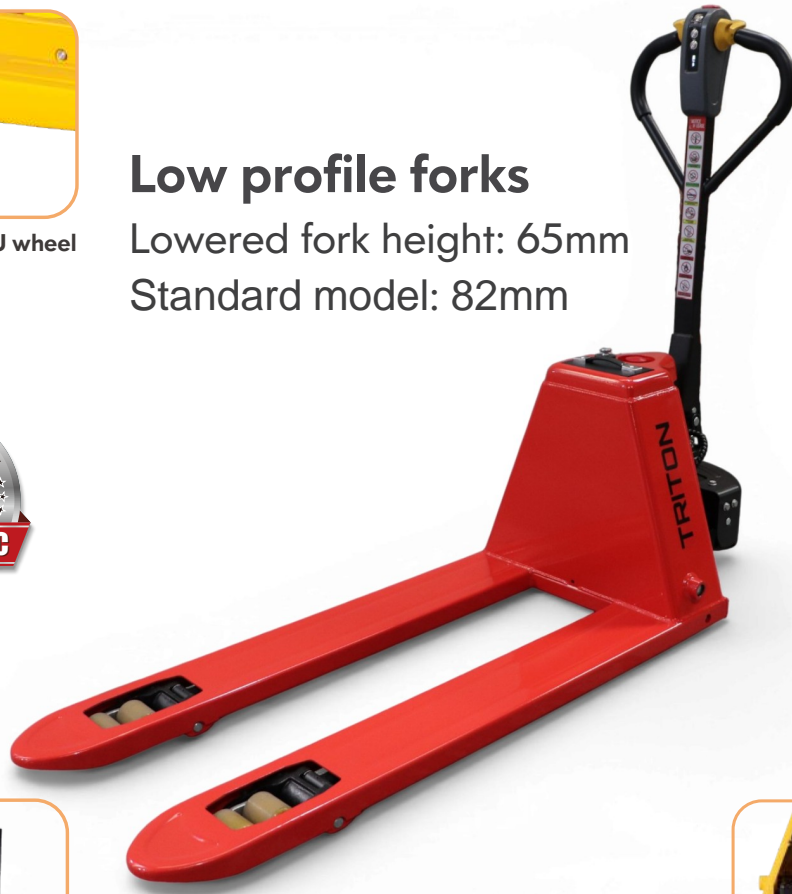

Lithium Battery



Protection cover
Protect the drive motor,
Anti-foot stamping



Intelligent charger

EPT20-A



Electric lifting/lowering

PPT20-A



Manual lifting/lowering

Dimensions

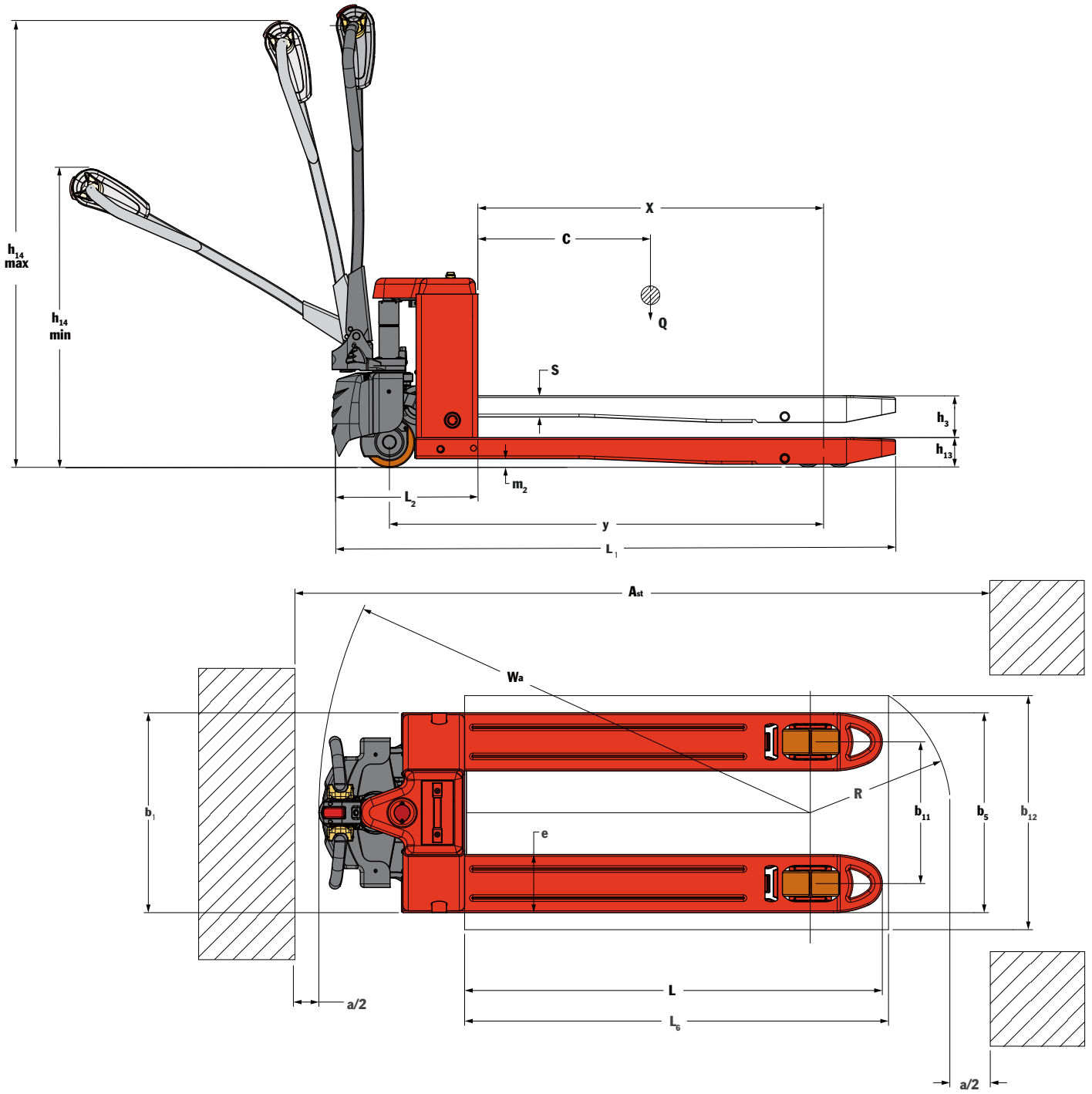

Specifications

| MODEL | | PPT20H | EPT15H | EPT20-A | EPT15H-65L |
|------------------------|---|--------------------|----------------------|----------------------|----------------------|
| CHARACTERISTICS | | | | | |
| 1.1 | Drive | | Electric | Electric | Electric |
| 1.2 | Operator type | | Pedestrian | Pedestrian | Pedestrian |
| 1.3 | Load capacity/rated load | Q kg | 2000 | 1500 | 2000 |
| 1.4 | Load centre | C mm | 600 | 600 | 600 |
| 1.5 | Height, fork lowered | h ₁₃ mm | 82 ± 2 | 82 ± 2 | 82 ± 2 |
| 1.6 | Wheelbase | y mm | 1197/1267 | 1197/1267 | 1197/1267 |
| 1.7 | Wheel | | PU | PU | PU |
| 1.8 | Wheel size, front | mm | 140*55 | 140*55 | 140*55 |
| 1.9 | Wheel size, rear | mm | 80*93 (Single Wheel) | 80*93 (Single Wheel) | 80*70 (Tandem) |
| | | mm | 80*70 (Tandem) | 80*70 (Tandem) | 60*70 (Single Wheel) |
| 1.10 | Wheels, number front/rear (x = drive wheels) | | 1x+2/4 | 1x+2/4 | 1x+2/4 |
| 1.11 | Lift | h ₃ mm | 195 | 195 | 195 |
| 1.12 | Height of tiller in drive position, min./max. | h ₁₄ mm | 740/1220 | 735/1170 | 735/1170 |
| 1.13 | Overall length | L ₁ mm | 1552/1622 | 1552/1622 | 1552 |
| 1.14 | Fork Length | L mm | 1150/1220 | 1150/1220 | 1150 |
| 1.15 | Overall width | b ₁ mm | 550/685 | 550/685 | 550 |
| 1.16 | Fork dimensions | mm | 58/160/1150(1220) | 58/160/1150(1220) | 58/160/1150 |
| 1.17 | Overall fork-arms Width | b ₅ mm | 550/685 | 550/685 | 550 |
| 1.18 | Ground clearance, centre of wheelbase | m ₂ mm | 22/137(24/139) | 22/137(24/139) | 22/137 |
| 1.19 | Aisle width for pallets 1000x1200 crossways | A _{st} mm | 2155/2226 | 2155/2226 | 2155/2226 |
| 1.20 | Aisle width for pallets 800x1200 lengthways | A _{st} mm | 2024/2064 | 2024/2064 | 2024/2064 |
| 1.21 | Turning radius | W _a mm | 1353/1426 | 1353/1426 | 1353 |
| PERFORMANCE | | | | | |
| 2.1 | Travel speed, laden/unladen | km/h | 4.0/4.5 | 4.0/4.5 | 4.0/4.5 |
| 2.2 | Lifting speed, laden/unladen | mm/s | / | 18/23 | 18/23 |
| 2.3 | Lowering speed, laden/unladen | mm/s | / | 56/46 | 56/46 |
| 2.4 | Max. gradeability, laden/unladen | % | 6%/20% | 6%/20% | 6%/20% |
| 2.5 | Drive motor | kW | DC 1.0 Brushless | DC 0.75 Brushless | DC 1.0 Brushless |
| 2.6 | Lift motor | kW | Hydraulic | DC 0.8 | DC 0.8 |
| BATTERY | | | | | |
| 3.1 | Battery voltage/nominal capacity | V/Ah | 48V/10Ah | 48V/10Ah | 48V/10Ah |
| 3.2 | Traveling brake | | Regenerate | Regenerate | Regenerate |
| 3.3 | Brake | | Electromagnetic | Electromagnetic | Electromagnetic |
| 3.4 | Sound level at the driver's ear according to EN 12053 | A | < 70dB | < 70dB | < 70dB |
| 3.5 | Service weight including battery | kg | 117/123.5 | 116.5/123 | 119/125.5 |

MAKE **YOUR JOB** **EASIER!**

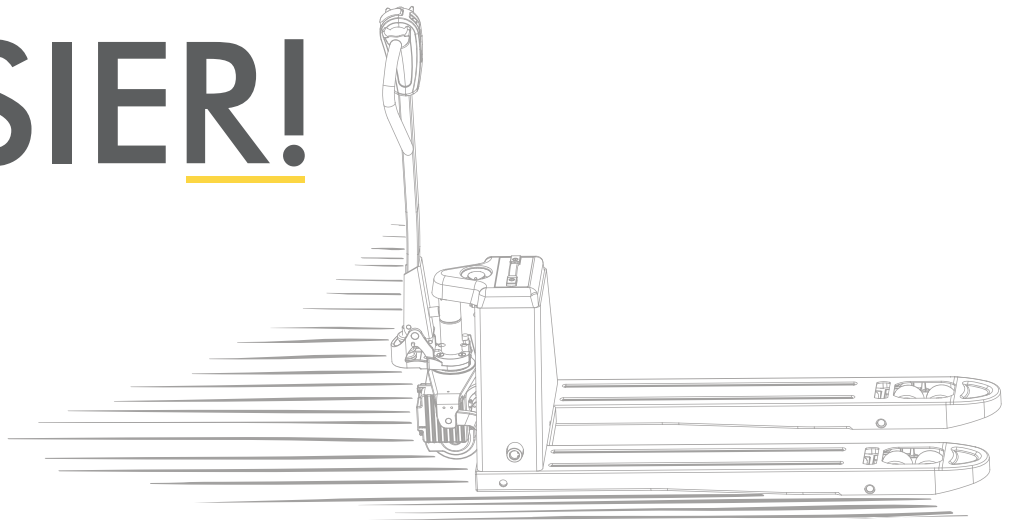

midland
pallet trucks

Email: sales@midlandpallettrucks.com

Phone: 01384 841440

Web: <http://www.midlandpallettrucks.com>

Add: Midland Pallet Trucks, Building 33 Second Avenue,
Pensnett Trading Estate, Kingswinford, DY6 7UG